



Cambridge IGCSE™

PHYSICS

0625/13

Paper 1 Multiple Choice (Core)

October/November 2023

45 minutes

You must answer on the multiple choice answer sheet.

You will need: Multiple choice answer sheet
Soft clean eraser
Soft pencil (type B or HB is recommended)

INSTRUCTIONS

- There are **forty** questions on this paper. Answer **all** questions.
- For each question there are four possible answers **A**, **B**, **C** and **D**. Choose the **one** you consider correct and record your choice in soft pencil on the multiple choice answer sheet.
- Follow the instructions on the multiple choice answer sheet.
- Write in soft pencil.
- Write your name, centre number and candidate number on the multiple choice answer sheet in the spaces provided unless this has been done for you.
- Do **not** use correction fluid.
- Do **not** write on any bar codes.
- You may use a calculator.
- Take the weight of 1.0 kg to be 9.8 N (acceleration of free fall = 9.8 m/s^2).

INFORMATION

- The total mark for this paper is 40.
- Each correct answer will score one mark.
- Any rough working should be done on this question paper.

This document has **16** pages. Any blank pages are indicated.



2

- 1 A student uses a metre ruler to measure the length of six identical table-tennis balls placed between two wooden blocks.

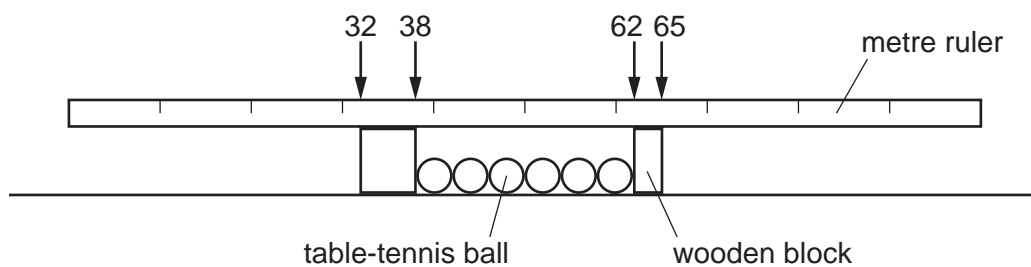

What is the diameter of one ball?

- A** 4 cm **B** 5 cm **C** 6 cm **D** 8 cm
- 2 A train is on a straight track. The graph shows how a quantity y varies with time.

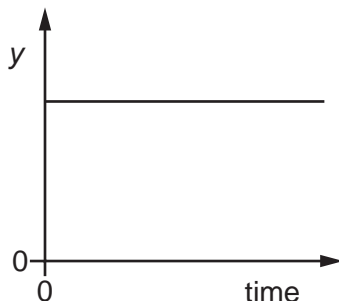

Which statements can be true?

- 1 The train is stationary and y represents the distance from the last station.
- 2 The train is moving and y represents the distance from the last station.
- 3 The train is stationary and y represents the speed of the train.
- 4 The train is moving and y represents the speed of the train.

- A** 1 and 2 **B** 1 and 4 **C** 2 and 3 **D** 3 and 4
- 3 A vehicle sent to explore the surface of Mars has a mass of 200 kg.

The acceleration of free fall on Mars is 3.7 m/s^2 .

What is the weight of the vehicle on Mars?

- A** 20 N **B** 54 N **C** 740 N **D** 2000 N

- 4 A student writes about mass and weight.

Which statement is correct?

- A A ship which is floating has mass but no weight.
 - B Mass is a scientific word that means the same as weight.
 - C Mass is measured in newtons.
 - D The mass of an astronaut is the same on the Moon as on the Earth.
- 5 A student carries out an experiment to determine the density of an irregularly shaped solid. The solid is placed on a balance and a reading is taken. The solid is then immersed in a liquid in a measuring cylinder.

Which values should be used in the calculation?

	value from measuring cylinder	value from balance
A	increase in reading after immersion of the solid	mass
B	increase in reading after immersion of the solid	weight
C	reading after immersion of the solid	mass
D	reading after immersion of the solid	weight

4

- 6 A uniform rod rests on a pivot at its centre. The rod is not attached to the pivot. Forces are then applied to the rod in four different ways, as shown. The weight of the rod can be ignored.

Which diagram shows the rod in equilibrium?

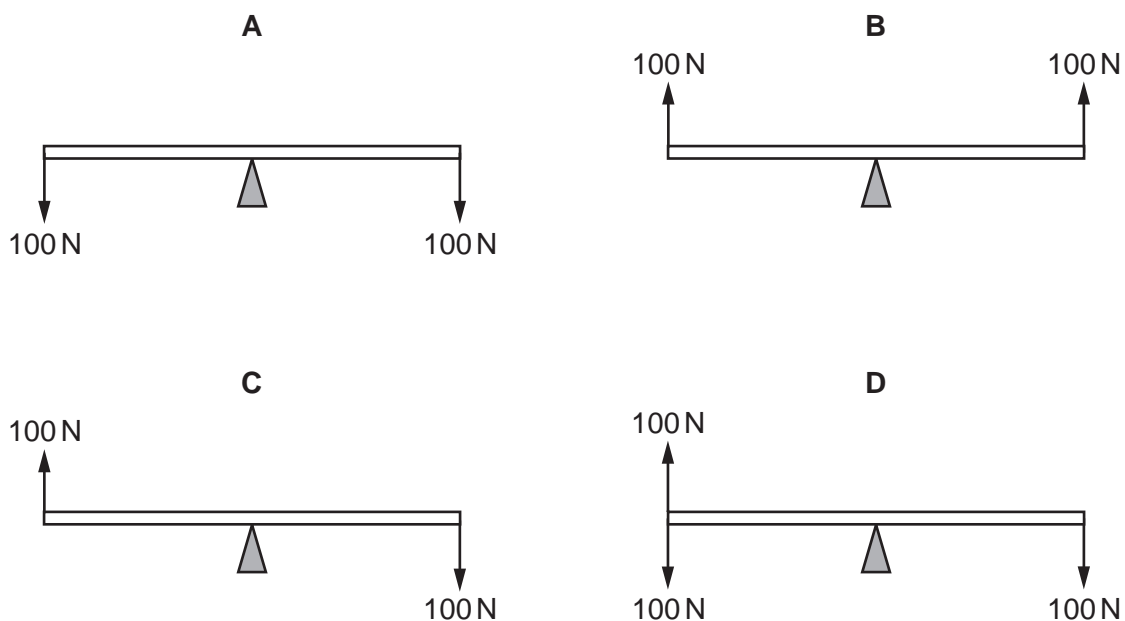

- 7 The diagram shows a beam balanced on a pivot. Two forces, X and Y , are acting on the beam.

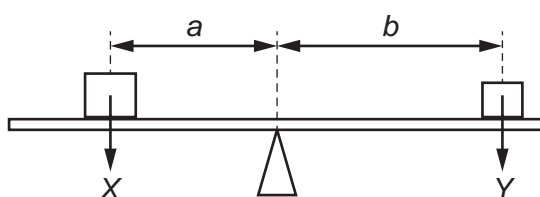

Which calculation gives the moment of the force Y about the pivot?

- A $Y \times (a + b)$ B $\frac{Y}{(a + b)}$ C $Y \times b$ D $\frac{Y}{b}$

5

- 8 A mass bounces up and down on a steel spring. The diagram shows the mass and the spring at different points during the motion.

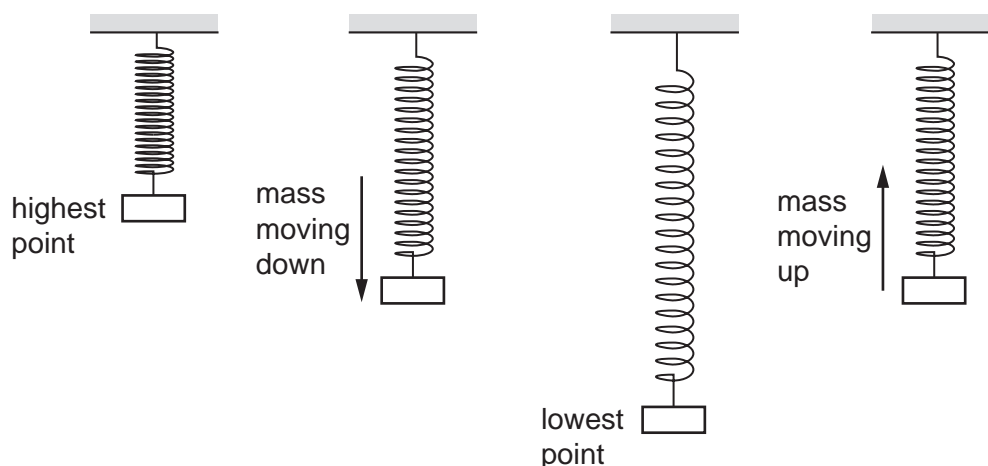

At which point is the least energy in the gravitational potential store of the mass and at which point is the most energy in the elastic store of the spring?

	least energy in gravitational potential store of the mass	most energy in the elastic store of the spring
A	mass moving down	mass moving up
B	mass moving down	lowest point
C	lowest point	mass moving up
D	lowest point	lowest point

- 9 Electrical power is generated from different resources. Some of these resources are listed.

- chemical energy stored in biofuels
- chemical energy stored in fossil fuels
- energy stored in tides
- geothermal resources
- hydroelectric resources
- light from the Sun
- nuclear fuel

How many of the resources listed are classified as renewable?

- A** 3 **B** 4 **C** 5 **D** 6

10 A microwave oven is rated at 900 watts.

Which statement correctly describes the meaning of this value?

- A 900 joules are transferred every second.
- B 900 amperes are transferred every second.
- C 900 volts are transferred every second.
- D 900 ohms are transferred every second.

11 Why is it easier to push a sharp nail, rather than a blunt nail, into a piece of wood?

- A The sharp nail exerts a larger force on the wood.
- B The sharp nail exerts a smaller force on the wood.
- C The sharp nail exerts a larger pressure on the wood.
- D The sharp nail exerts a smaller pressure on the wood.

12 A sealed bottle of constant volume contains air.

The air in the bottle is heated by the Sun.

What is the effect on the average speed of the air particles in the bottle and the average distance between them?

	average speed of air particles	average distance between air particles
A	decreases	decreases
B	decreases	stays the same
C	increases	increases
D	increases	stays the same

13 Which graph shows the relationship between the pressure p of a fixed mass of gas and its volume V at a constant temperature?

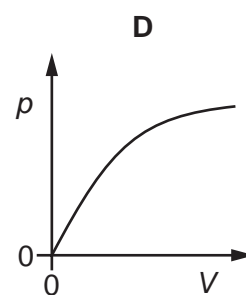
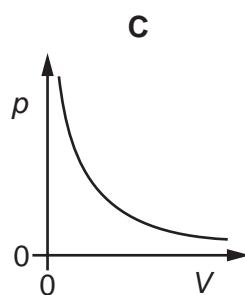
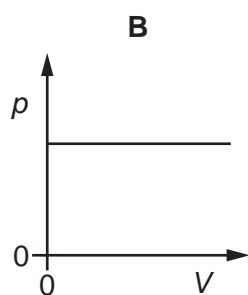
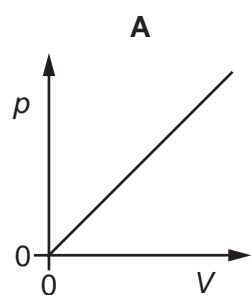

- 14 What happens when a metal block is heated?
- A Its width, height and length all increase.
 B Its width increases only.
 C Its height increases only.
 D Its length increases only.
- 15 Which statement about the temperature of the solid describes what happens when a solid is melting?
- A The temperature increases and there is an input of energy.
 B The temperature increases and there is no input of energy.
 C The temperature remains constant and there is an input of energy.
 D The temperature remains constant and there is no input of energy.
- 16 A cupboard is placed in front of a heater. Air can move through a gap under the cupboard.

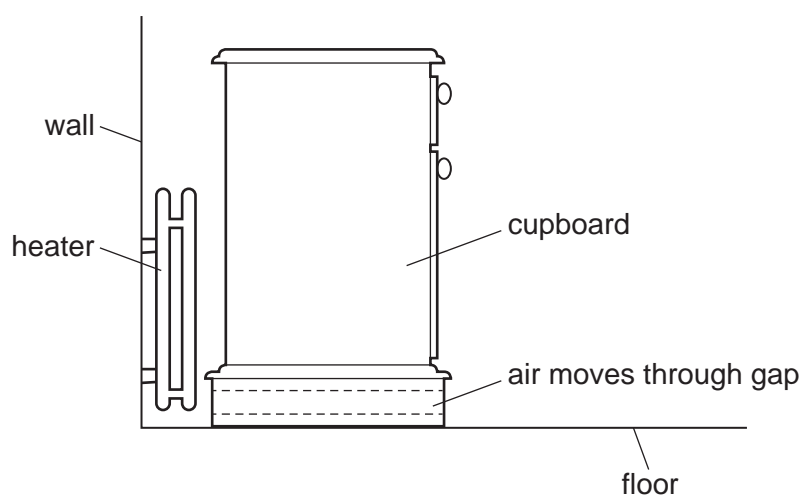

Which row describes the temperature and the direction of movement of the air in the gap?

	air temperature	air direction
A	cool	away from the heater
B	cool	towards the heater
C	warm	away from the heater
D	warm	towards the heater

17 Which statement about waves is correct?

- A All waves can travel through a vacuum.
- B All waves travel at the same speed.
- C Seismic S-waves can be modelled as longitudinal waves.
- D Waves transfer energy without transferring matter.

18 The diagram shows a transverse wave.

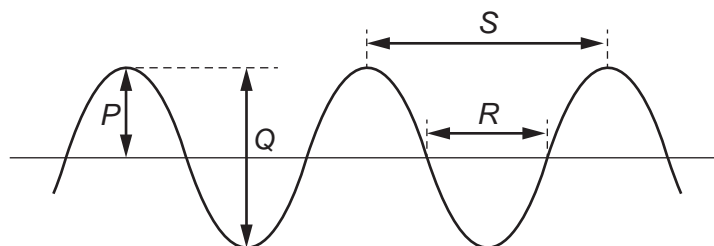

Which row identifies the amplitude and the wavelength of the wave?

	amplitude	wavelength
A	<i>P</i>	<i>R</i>
B	<i>P</i>	<i>S</i>
C	<i>Q</i>	<i>R</i>
D	<i>Q</i>	<i>S</i>

19 A beam of light from the Sun strikes a prism.

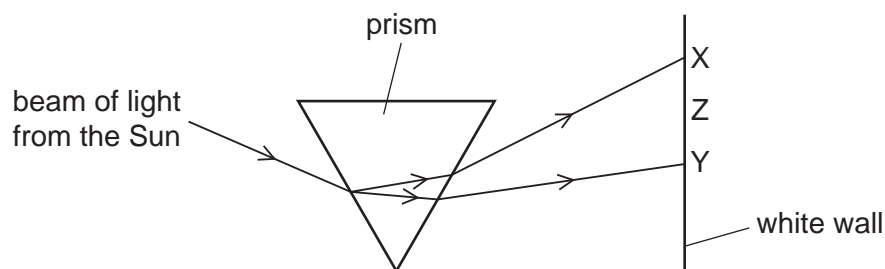

The dispersed beam is incident on a white wall between X and Y.

Which colours are seen at X, Z and Y?

	X	Z	Y
A	red	green	violet
B	red	violet	green
C	violet	green	red
D	violet	red	green

- 20 The diagram shows a ray of light incident on a plane mirror.

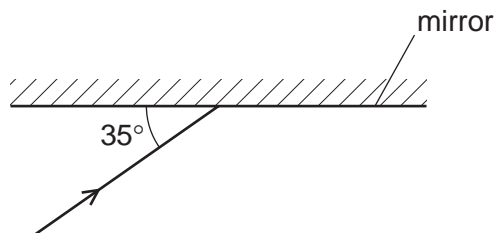

The angle between the ray and the mirror is 35° .

The ray is reflected by the mirror.

What is the angle of reflection?

- A 35° B 55° C 70° D 110°
- 21 A thin converging lens in a camera produces a real image on a photo-sensitive surface, as shown.

At which position is the image of the top of the object formed?

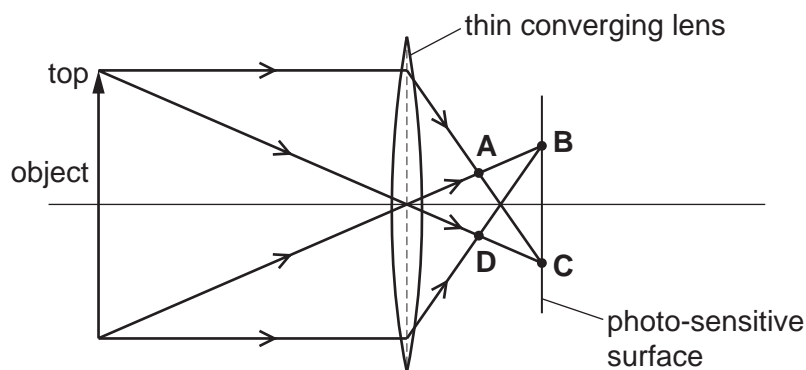

- 22 The diagram shows the electromagnetic spectrum.

γ -rays	E	ultraviolet	F	infrared	microwaves	G
----------------	---	-------------	---	----------	------------	---

Which types of wave are E, F and G?

	E	F	G
A	radio	visible light	X-rays
B	radio	X-rays	ultrasound
C	X-rays	radio	ultrasound
D	X-rays	visible light	radio

23 A sound is produced and an echo is heard after the sound reflects off a wall.

How do the properties of the echo compare to the original sound wave?

	amplitude	frequency	speed
A	lower	lower	lower
B	lower	same	same
C	same	lower	lower
D	same	same	same

24 Which metal can be attracted by a magnet?

- A** zinc
- B** lead
- C** iron
- D** copper

25 A student uses an ammeter to measure the current in a resistor. He considers three different circuits, as shown.

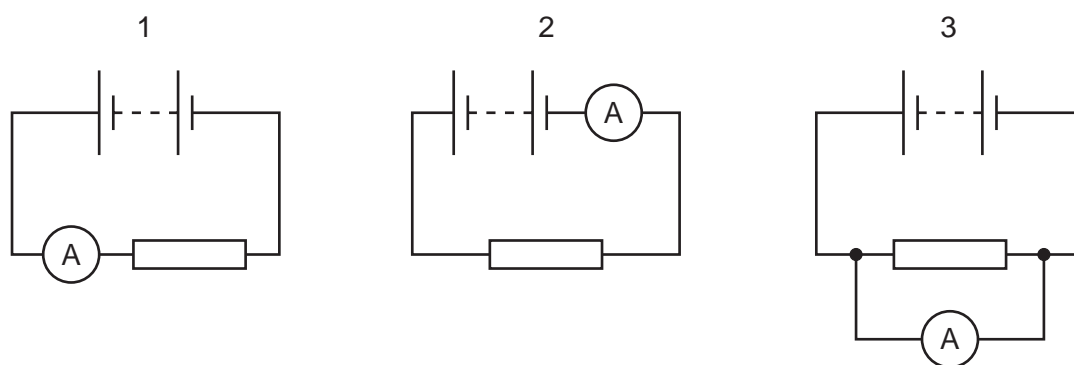

In which of the circuits does the ammeter measure the current in the resistor?

- A** 1, 2 and 3
- B** 1 and 2 only
- C** 1 only
- D** 3 only

26 Which substances both contain large concentrations of free electrons?

- A** aluminium and glass
- B** copper and water
- C** copper and nylon
- D** silver and gold

27 What is the unit of resistance?

- A ampere
- B ohm
- C volt
- D watt

28 A teacher wishes to show the production of electrostatic charges.

She holds a rod and rubs it with a cotton cloth. A copper rod, a glass rod, a plastic rod and a steel rod are available.

Which two rods would both be suitable to use?

- A a copper rod and a glass rod
- B a glass rod and a plastic rod
- C a plastic rod and a copper rod
- D a plastic rod and a steel rod

29 Resistors of resistance $2.0\ \Omega$ and $3.0\ \Omega$ are connected in two different circuits.

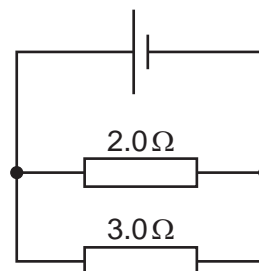
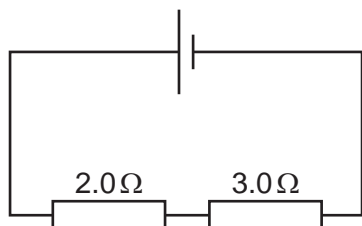

What is the total resistance in each circuit?

	series	parallel
A	less than $2.0\ \Omega$	less than $2.0\ \Omega$
B	less than $2.0\ \Omega$	greater than $3.0\ \Omega$
C	greater than $3.0\ \Omega$	less than $2.0\ \Omega$
D	greater than $3.0\ \Omega$	greater than $3.0\ \Omega$

- 30 The current in an electrical heater is 5.0 A.

The heater is connected to the mains by a flexible cable that can carry a current of up to 15 A.
The mains circuit can carry a current of up to 30 A.

Different fuses are available to protect the heater's cable.

Which fuse is the most suitable?

- A** 4.0 A **B** 10 A **C** 20 A **D** 40 A
- 31 A generator uses the principle of electromagnetic induction.

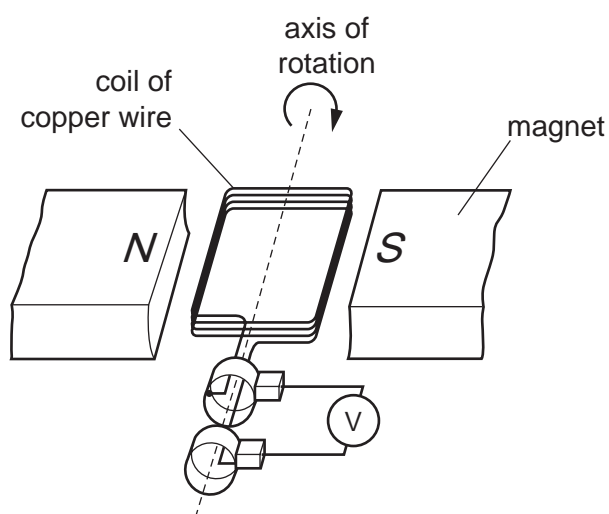

Which change would increase the induced electromotive force (e.m.f.) in the coil?

- A** increasing the number of turns in the coil
B placing the magnets further apart
C using a coil made from steel wire
D reversing one of the magnets

32 A current passes along a wire placed between the poles of a permanent magnet.

The wire experiences a force due to the magnetic field.

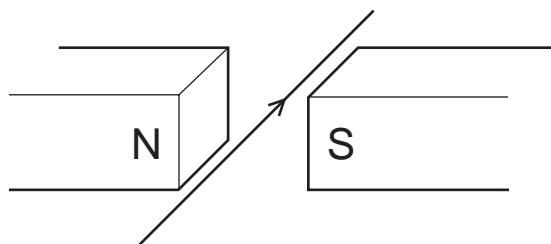

What will change the direction of this force?

- A increasing the current
 - B reversing the current
 - C increasing the strength of the magnetic field
 - D using an electromagnet with the same polarity as the permanent magnet
- 33 What is a transformer used for?
- A changing a direct current into an alternating current
 - B changing the magnitude of an alternating voltage
 - C reducing the frequency of an alternating current
 - D switching off the current in a circuit when there is a fault
- 34 What are the relative charges on a proton, a neutron and an electron?

	proton	neutron	electron
A	0	-1	+1
B	0	-1	-1
C	+1	0	-1
D	+1	0	+1

- 35 The half-life of carbon-14 is 5700 years.

An object containing carbon-14 has a count rate of 100 counts/minute when it is first formed. The graph shows how the count rate decreases over time.

Which point on the graph corresponds to a time 11 400 years after the formation of the object?

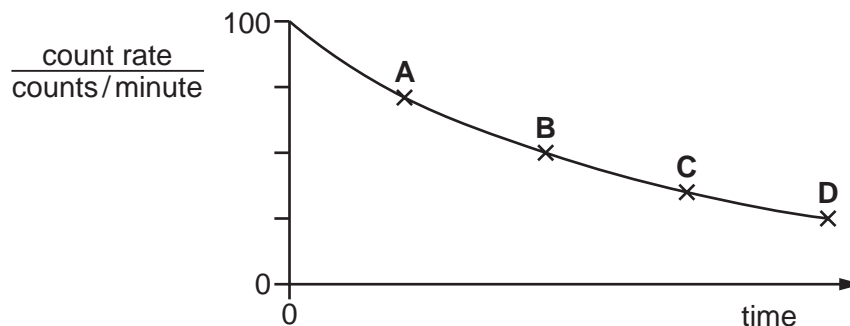

- 36 Which type of radioactive decay causes the nucleus of one element to change into the nucleus of another element?

	emission of an alpha-particle	emission of a beta-particle	emission of a gamma ray
A	✓	✓	x
B	✓	x	x
C	x	✓	✓
D	x	✓	x

- 37 A scientist needs to use a source of γ -rays as safely as possible.

Which action will **not** reduce the total radiation that reaches the scientist?

- A** keeping the distance between the source and the scientist as large as possible
 - B** keeping the temperature of the source as low as possible
 - C** keeping the time for which the scientist uses the source as small as possible
 - D** placing a lead screen between the scientist and the source
- 38 Which time period is approximately equal to 24 hours?
- A** the time for the Earth to complete one rotation on its axis
 - B** the time for the Earth to orbit the Sun
 - C** the time for the Moon to orbit the Earth
 - D** the time for the Sun to orbit the Earth

39 The nearest star to the Sun is about four light-years away from the Earth.

A student makes three statements about the star.

- 1 Light from the star takes about four years to reach the Earth.
- 2 Light from the Sun takes about four years to travel to the star and back to the Earth.
- 3 The star is outside our galaxy.

Which statements are correct?

- A** 1, 2 and 3 **B** 1 and 3 only **C** 1 only **D** 2 and 3 only

40 The table shows some elements and some regions of the electromagnetic spectrum.

Which row shows one of the most common elements in the Sun and one of the regions in which the Sun radiates most of its energy?

	element	region
A	iron	gamma
B	iron	infrared
C	hydrogen	gamma
D	hydrogen	infrared

BLANK PAGE

Permission to reproduce items where third-party owned material protected by copyright is included has been sought and cleared where possible. Every reasonable effort has been made by the publisher (UCLES) to trace copyright holders, but if any items requiring clearance have unwittingly been included, the publisher will be pleased to make amends at the earliest possible opportunity.

To avoid the issue of disclosure of answer-related information to candidates, all copyright acknowledgements are reproduced online in the Cambridge Assessment International Education Copyright Acknowledgements Booklet. This is produced for each series of examinations and is freely available to download at www.cambridgeinternational.org after the live examination series.

Cambridge Assessment International Education is part of Cambridge Assessment. Cambridge Assessment is the brand name of the University of Cambridge Local Examinations Syndicate (UCLES), which is a department of the University of Cambridge.